





Hochsichtbare Warnkleidung  2 EN ISO 20471:2013 + A1:2016	Schutzkleidung Schutz gegen Hitze und Flammen  EN ISO 11612:2015 A1+A2 B1 C1 E3 F1	Schutzkleidung Schweißen und verwandte Verfahren  EN ISO 11611:2015 Klasse 2 A1+A2	Schutzkleidung Elektrostatische Eigenschaften  EN 1149-5:2018	Schutzkleidung Thermische Gefahren eines Lichtbogens  IEC 61482-2:2018 APC 2
---	---	---	---	---

ATPV vom Gewebe: 18 cal/cm²

teamdress®

Bundhose HighVis Multinorm

Art. 7181, Farbe 911

- + Knöpfe und Reißverschlüsse aus Kunststoff
- + 7 Gürtelschlaufen
- + Bundverschluss mit verdecktem Kunststoffknopf
- + im Schlitz Reißverschluss
- + 2 Seitentaschen mit verdecktem Druckknopf
- + 1 Gesäßtasche mit Patte und verdeckten Druckknöpfen
- + 1 Beintasche mit Patte und verdeckten Druckknöpfen
+ innenliegende Handytasche
- + 1 nach innen und außen verstärkte Maßstabtasche mit Patte und verdeckten Druckknöpfen
- + Knietaschen mit Klett
- + Beine mit je 2 Reflexstreifen (7 cm breit)

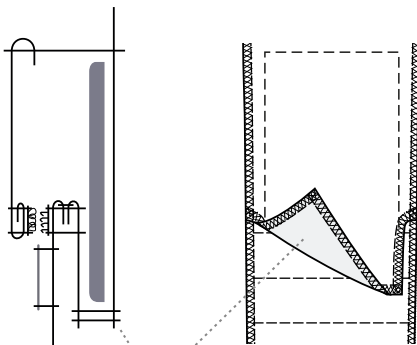
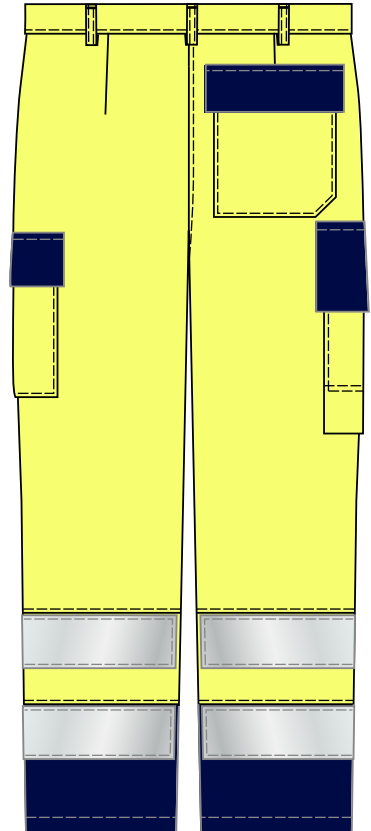
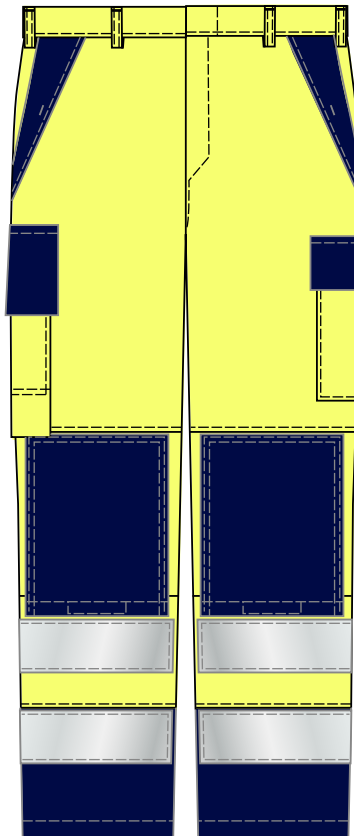
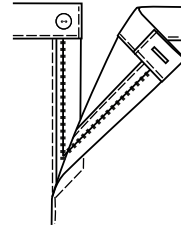
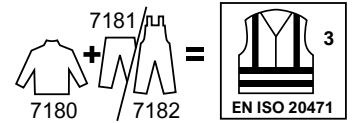

Beutel lose
Reflexstreifen und
Knietaschen können
leicht ausgetauscht werden

- + Größen: 44 - 66
94 - 114
22 - 33

- + Pflege:

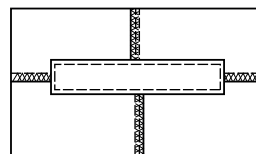

Schrittverstärkung

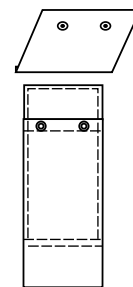

Maßstabtasche

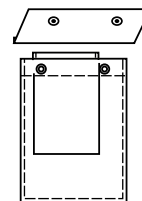

Beintasche
+ Handytasche

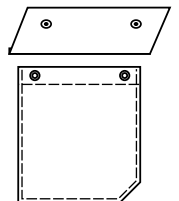

Gesäßtasche

- + Farben:

warngelb / marine



- + Material: 52% Baumwolle / 22% Modacryl / 19% Viskose / 6% Para-Aramid / 1% Antistatik, 450 g/m²