





<p>Hochsichtbare Warnkleidung</p>  <p>EN ISO 20471:2013 + A1:2016</p>	<p>Schutzkleidung Schutz gegen Hitze und Flammen</p>  <p>EN ISO 11612:2015 A1+A2 B1 C1 D3 E3 F1</p>	<p>Schutzkleidung Schweißen und verwandte Verfahren</p>  <p>EN ISO 11611:2015 Klasse 2 A1+A2</p>	<p>Schutzkleidung Elektrostatische Eigenschaften</p>  <p>EN 1149-5:2018</p>	<p>Schutzkleidung Thermische Gefahren eines Lichtbogens</p>  <p>IEC 61482-2:2018 APC 2</p>
--	--	---	--	---

ATPV vom Gewebe: 18 cal/cm²

teamdress®

Bundhose HighVis Multinorm

Art. 6181, Farbe 911

- + Knöpfe und Reißverschlüsse aus Kunststoff
- + 7 Gürtelschlaufen
- + Bundverschluss mit verdecktem Kunststoffknopf
- + im Schlitz Reißverschluss
- + 2 Seitentaschen mit verdecktem Druckknopf
- + 1 Gesäßtasche mit Patte und verdeckten Druckknöpfen
- + 1 Beintasche mit Patte und verdeckten Druckknöpfen + innenliegende Handytasche
- + 1 nach innen und außen verstärkte Maßstabtasche mit Patte und verdeckten Druckknöpfen
- + Knietaschen mit Klett
- + Beine mit je 2 Reflexstreifen (7 cm breit)

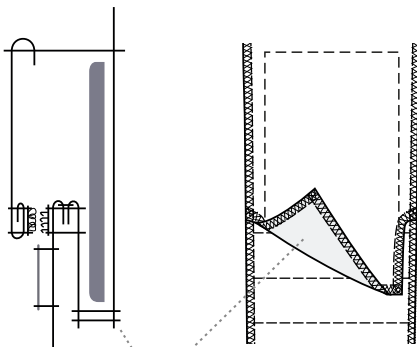
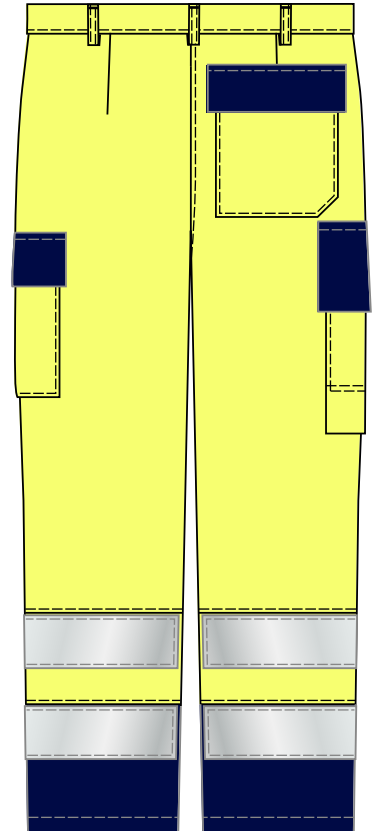
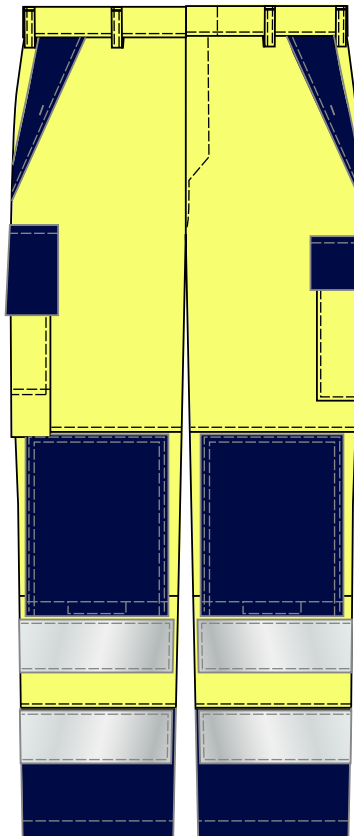
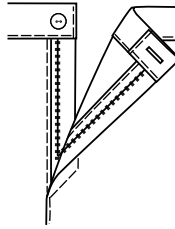
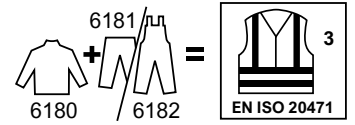

Beutel lose
Reflexstreifen und
Knietaschen können
leicht ausgetauscht werden

- + Größen: 44 - 66
94 - 114
22 - 33

+ Pflege:

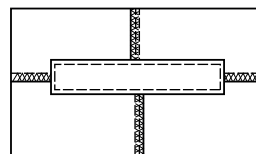

Schrittverstärkung

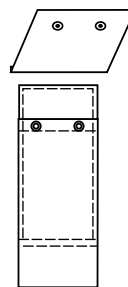

Maßstabtasche

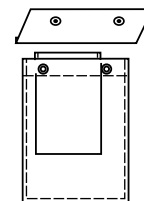

Beintasche + Handytasche

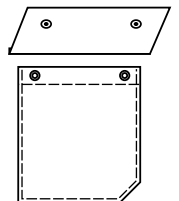

Gesäßtasche

+ Farben:

warngelb / marine



- + Material: 52% Baumwolle / 22% Modacryl / 19% Viskose / 6% Para-Aramid / 1% Antistatik, 450 g/m²